

Article number: 204360M1637D1X
 Description: E+G levelling foot
 GN 43-60-M16-37-D1-X
 Note: X With female thread, External hexagon

Measures

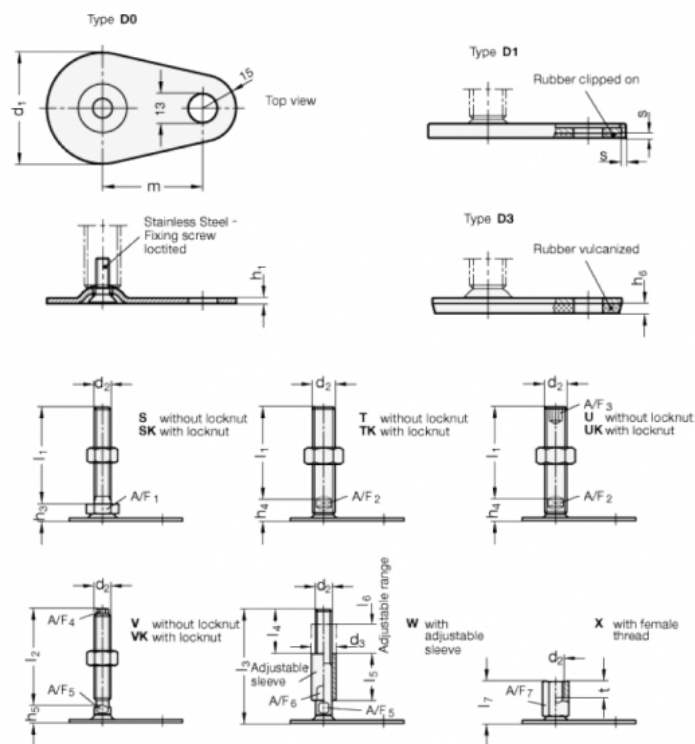

A/F7 = 22	t = 16
d1 = 60	
d2 = M16	
h1 = 2.5	
h6 =	
l7 = 37	
m = 70	
s = 2	